

TELESCOPIC RESCUE CYLINDER RZT 2-600

Part no.
5936934



 DISTANCE

 SINGLE

 PUSH-CONTROL

Technical specifications:

Closed length (retracted)	300 mm
Final length (extended)	600 mm
Stroke stage 1 / stroke stage 2	165 mm / 135 mm
Force stage 1 / force stage 2	189,4 kN / 99,0 kN
Weight (ready for use)	9,1 kg
Required oil volume	0,5 l
Dimensions (LxWxH)	300 x 295 x 88 mm
Nominal pressure	700 bar
EN classification (EN 13204)	TR189/165-99/135-9,1

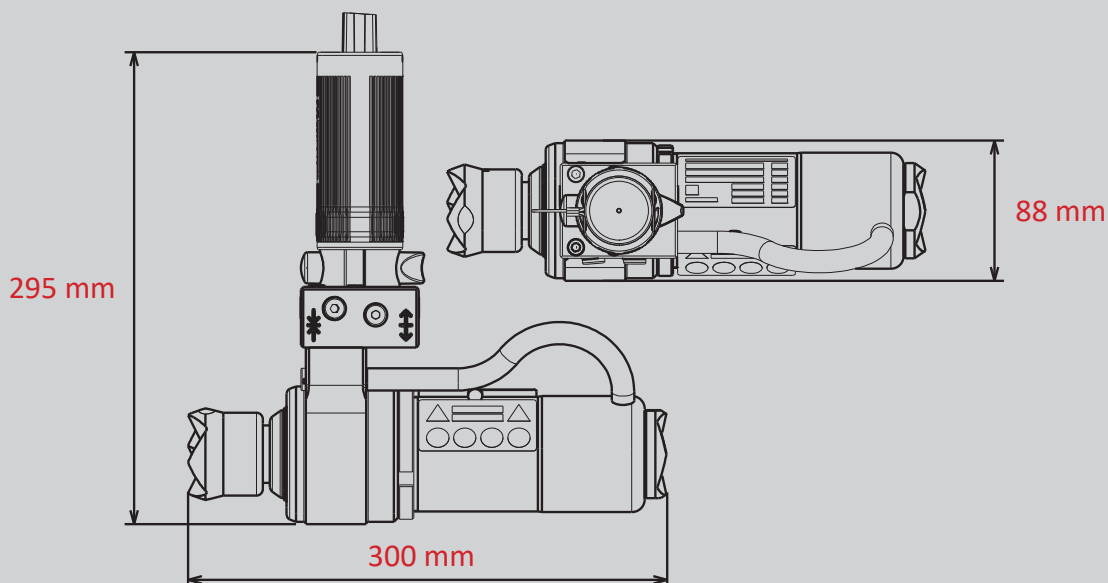

Images are non-binding. We reserve the right to technical modifications.
60005132 (-, -, ALL, 04.07.2019)